

SunCoast Elevator Co



LEV[®]

The Next Level.[™]

Planning Guide

for Residential Elevators

ASME A17.1, Part V, Section 5.3

November 26, 2008

ThyssenKrupp Access
888 229 0940 Ph



ThyssenKrupp

Introduction

This Planning Guide is designed to assist architects, contractors, home owners and elevator professionals in planning for a home elevator that meets the requirements of ASME A17.1 Part V Section 5.3.

We strongly recommend you contact the codes authority having jurisdiction in the area(s) where the elevator will be installed. Become familiar with all requirements governing the installation and use of elevators in private residences. It is extremely important for you to know and adhere to all regulations concerning installation and use of elevators.

IMPORTANT NOTICE:

This Planning Guide provides nominal dimensions and specifications useful for INITIAL planning of an elevator project. BEFORE beginning actual construction, be sure to receive application drawings customized with specifications and dimensions for your specific project. Call 1-800-829-9760 to find a dealer in your area or visit our website, www.tkaccess.com and click on "Request Information".

Elevator configurations and dimensions are in accordance with our interpretation of the standards set forth by ASME A17.1 Part V Section 5.3. Please consult ThyssenKrupp Access or an authorized dealer in your area for more specific information pertaining to your project, including any deviation between referenced standards and those of any local codes or laws. Always contact local codes authorities for any variation to standards.

The dimensions and specifications in this Planning Guide are subject to constant change (without notice) due to product enhancements and continually evolving codes and product applications.

This elevator requires 230 VAC, single phase 60 Hz circuit with **neutral and ground**. 20 amp circuit for counterweighted chain drive.

Steps of planning for a Lev® Home Elevator:

1. Determine customer's intention for use.
2. Determine code requirements of site.
3. Determine installation parameters of site.
4. Determine the car type and hoistway size requirements (see pages 4 through 6).

Contents

Equipment for Lev residential elevator.....	4
Hoistway size requirements (pocketed gates).....	5-7
Hoistway size requirements (optional, non-pocketed gates)	8-10
Hoistway construction notes	11
Guide rail backing construction details	11
Rail reactions.....	11
Typical counterweighted chain drive area construction details	12
Optional drive unit area construction details with remote located controller	13
Service Access Hatch	14
Description of features	15-17
3-Part specifications	18-21
Counterweighted chain drive overview	22

EQUIPMENT FOR LEV RESIDENTIAL ELEVATOR

This elevator meets the requirements of ASME A17.1
Part V, Section 5.3 for a residential elevator.

General:

- Speed: 40 fpm (.20ms)
- Minimum pit depth: 6"
- Maximum travel: 50'
- Maximum number of stops: 5
(minimum 17" travel between stops)
- Rated load: 950 lbs. (430 kg) (750 and 700 lbs. available)
- Minimum overhead clearance 9'-0"

Mechanical Equipment:

- 230 VAC, 60 Hz, 20 amp single phase power supply with neutral and ground (4 wires)
- Two #60 roller chains
- Frequency controlled variable speed geared machine with counterweighted chain drive, 2 hp motor
- Modular Dual 6³/₄ lb. T-rail system
- Sling assembly

Car and Appointments:

- 36" x 48" (12 ft²) x 84" high car size
- Melamine wall panels in choice of champagne, light oak, dark oak or white
- White ceiling
- Two recessed halogen lights
- Wooden handrail to match wall panels
- Unfinished plywood floor (with removable insert for ³/₄" thick finished floor by others)
- Telephone

Controls:

- Programmable Logic Controller (PLC) with digital signal processor
- Fully automatic operation
- Car operating panel (brushed stainless steel or brass) with LED floor position/diagnostic display and call acknowledgment
- Hall stations (brushed stainless steel or brass) with LED floor position/diagnostic display and call acknowledgment
- Automatic car lighting with constant on switch
- Automatic homing to a designated floor
- Bi-directional leveling
- Emergency stop switch
- Emergency alarm button
- Hoistway wiring with conduit (hall stations / interlocks)
- Uninterruptible power supply (UPS) for lowering and automatic gate operation (if supplied) in case of a power failure

Safety Devices:

- Slack chain safety device
- Lockable auxiliary disconnect for car lighting circuit
- Lockable auxiliary disconnect for drive unit circuit
- Upper and lower terminal limits
- Final limits (2 upper, 1 lower)
- Pit switch
- Car top stop switch
- Battery backup emergency light and alarm
- Car gate safety switch
- Electromechanical interlocks (for doors by others)

Options:

- Remote located electrical controller
- 36" x 60" (15 ft²) or 40" x 54" (15 ft²) car sizes (custom sizes are available in 1" increments from 36" to 42" width by 48" to 60" depth - 12 ft² minimum, 15 ft² maximum)
- Special car size (15 ft² maximum, 12 ft² minimum)
- 88" or 94" inside car heights (requires additional overhead space)
- Unfinished wood veneer panels (oak, cherry or birch)
- Unfinished inset wood veneer panel walls (oak, cherry, maple or birch)

- Factory applied finish to wood veneer panels and handrail
- Raised wood panel walls (oak, cherry, maple or birch) with choice of finish. See available finishes at www.tkaccess.com/minwax
- Recessed telephone cabinet (brushed stainless steel or brass, or polished stainless steel or brass)
- Matching wood veneer ceiling panel*
- Hall stations and car operating panel can be provided in polished stainless steel or brass
- Metal handrail* (brushed stainless steel or brass, or polished stainless steel or brass)
- Automatic car gate operator
- Automatic hoistway door operator
- GAL Type 'N' interlocks (requires additional hoistway space)
- Buffer springs (requires 12" deep pit minimum)

Car Gate Upgrades:

- Accordion car gate with 3 clear vision panels
- Accordion car gate with all clear vision panels
- Deluxe Visifold® accordion car gate
- Accordion car gate with solid aluminum panels (clear or brass anodized finish)
- Accordion car gate with perforated aluminum panels (clear or brass anodized finish)
- Accordion car gate in choice of champagne, chalk, light oak, dark oak or white
- Non-Pocketed gate available on all Lev elevator cabs

Control Upgrades:

- Key switch controls in car operating panel and/or hall stations

*Not available with melamine wall panels.

Note: All dimensions are to inside finished walls.

The tables on pages 4 - 6 illustrate standard pocket gates that allow a larger clear opening in the doorway. The tables on pages 7 and 8 illustrate the three standard car sizes with optional non-pocketed gates. Custom sizes are available in 1" increments from 36" to 42" width by 48" to 60" depth (12 ft² minimum, 15 ft² maximum). Consult ThyssenKrupp Access for hoistway details.

Note: All dimensions are to inside finished walls.

Type 1 - Left Hand Car with Standard Pocket Gate Gate Stack - Rail Side

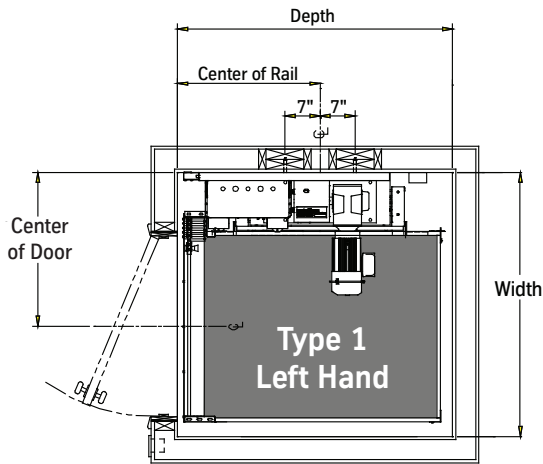

Car Size	Width	Depth	Center of Rail	Center of Door	Clear Opening
36 x 48	52 ³ / ₄ "	55"	28 ¹ / ₂ "	30 ³ / ₄ "	32 ¹ / ₈ "
36 x 60	52 ³ / ₄ "	67"	33 ¹ / ₂ "	30 ³ / ₄ "	32 ¹ / ₈ "
40 x 54	56 ³ / ₄ "	61"	30 ¹ / ₂ "	34 ³ / ₄ "	35 ⁷ / ₈ "

Type 1 - Right Hand Car with Standard Pocket Gate Gate Stack - Rail Side

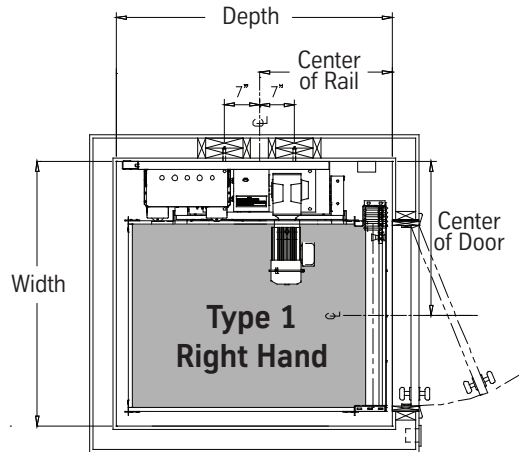

Car Size	Width	Depth	Center of Rail	Center of Door	Clear Opening
36 x 48	52 ³ / ₄ "	55"	28 ¹ / ₂ "	30 ³ / ₄ "	32 ¹ / ₈ "
36 x 60	52 ³ / ₄ "	67"	33 ¹ / ₂ "	30 ³ / ₄ "	32 ¹ / ₈ "
40 x 54	56 ³ / ₄ "	61"	30 ¹ / ₂ "	34 ³ / ₄ "	35 ⁷ / ₈ "

Type 1 - Left Hand Car with Standard Pocket Gate Gate Stack - Opposite Rail

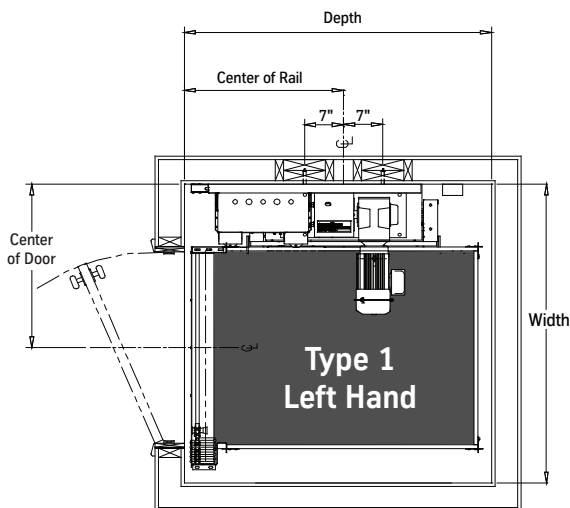

Car Size	Width	Depth	Center of Rail	Center of Door	Clear Opening
36 x 48	56 ¹ / ₄ "	55"	28 ¹ / ₂ "	30 ³ / ₄ "	32 ¹ / ₈ "
36 x 60	56 ¹ / ₄ "	67"	33 ¹ / ₂ "	30 ³ / ₄ "	32 ¹ / ₈ "
40 x 54	60 ¹ / ₄ "	61"	30 ¹ / ₂ "	34 ³ / ₄ "	35 ⁷ / ₈ "

Type 1 - Right Hand Car with Standard Pocket Gate Gate Stack - Opposite Rail

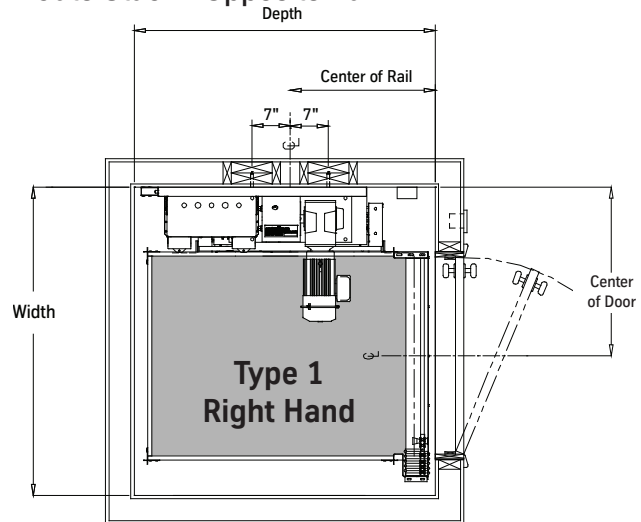

Car Size	Width	Depth	Center of Rail	Center of Door	Clear Opening
36 x 48	56 ¹ / ₄ "	55"	26 ¹ / ₂ "	30 ³ / ₄ "	32 ¹ / ₈ "
36 x 60	56 ¹ / ₄ "	67"	33 ¹ / ₂ "	30 ³ / ₄ "	32 ¹ / ₈ "
40 x 54	60 ¹ / ₄ "	61"	30 ¹ / ₂ "	34 ¹ / ₂ "	35 ⁷ / ₈ "

Type 2 - Straight-thru Car with Standard Pocket Gates Gate Stack - Rail Side

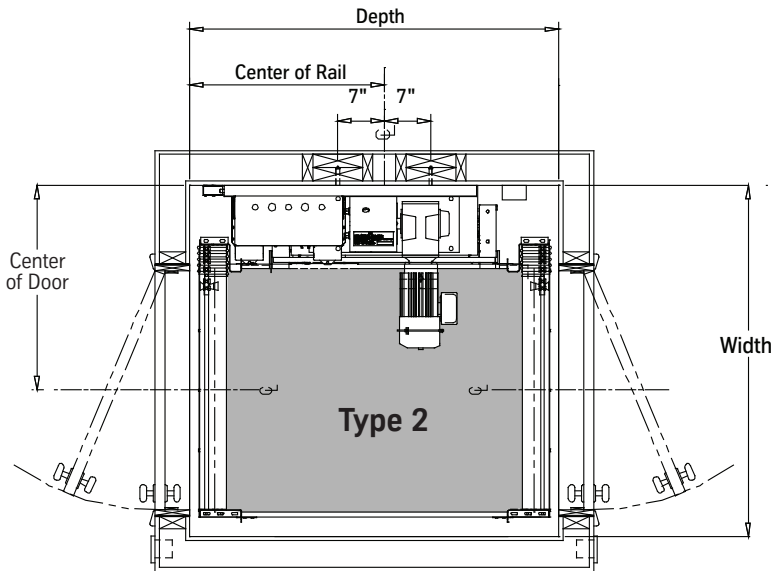

If this configuration is used with an automatic gate operator, a remote controller or 9'-0" overhead is required.

Note:

All dimensions are to inside finished walls.

All hoistway sizes shown are for use with standard electromechanical interlocks. Hoistway sizes change when using optional G.A.L. interlocks. For G.A.L. dimensions and more detailed information of all hoistway sizes, go to: www.tkaccess.com/levhoistway

Car Size	Width	Depth	Center of Rail	Center of Door	Clear Opening
36 x 48	52 ³ / ₄ "	55 ¹ / ₂ "	29 ¹ / ₄ "	30 ³ / ₄ "	32 ¹ / ₈ "
36 x 60	52 ³ / ₄ "	67 ¹ / ₂ "	33 ³ / ₄ "	30 ³ / ₄ "	32 ¹ / ₈ "
40 x 54	56 ³ / ₄ "	61 ¹ / ₂ "	30 ³ / ₄ "	34 ³ / ₄ "	35 ⁷ / ₈ "

Type 2 - Straight-thru Car with Standard Pocket Gates Gate Stack - Opposite Rail

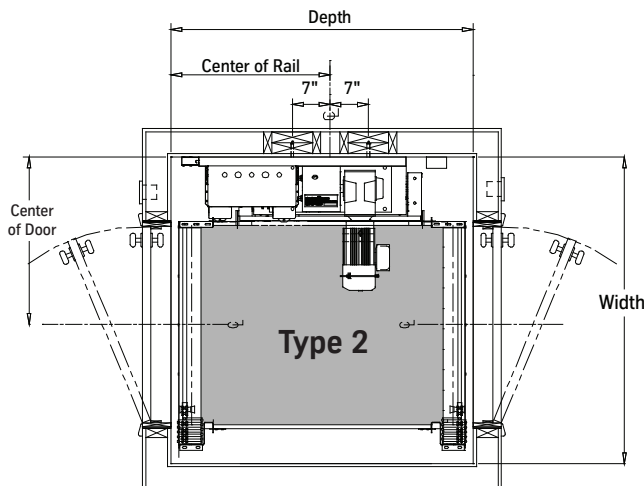

Car Size	Width	Depth	Center of Rail	Center of Door	Clear Opening
36 x 48	56 ¹ / ₄ "	55 ¹ / ₂ "	29 ¹ / ₄ "	30 ³ / ₄ "	32 ¹ / ₈ "
36 x 60	56 ¹ / ₄ "	67 ¹ / ₂ "	33 ³ / ₄ "	30 ³ / ₄ "	32 ¹ / ₈ "
40 x 54	60 ¹ / ₄ "	61 ¹ / ₂ "	30 ³ / ₄ "	34 ³ / ₄ "	35 ⁷ / ₈ "

Note: All dimensions are to inside finished walls.

Note: All dimensions are to inside finished walls.

Type 3 - Car with Standard Pocket Gate

Pocket gate only available with gate stack on rail side.

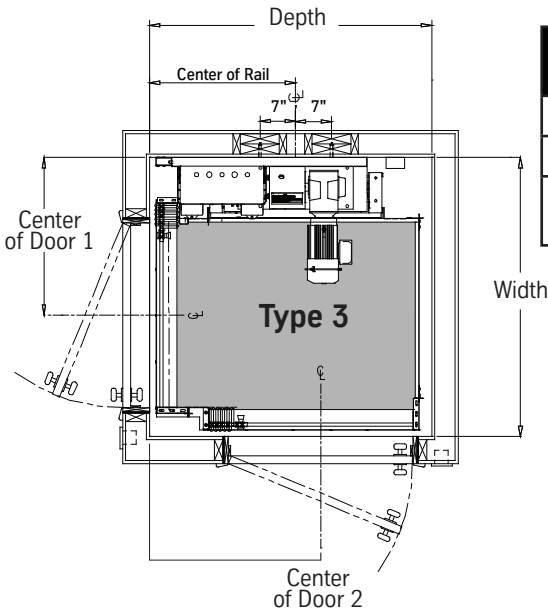

Car Size	Width	Depth	Center of Rail	Center of Door 1	Center of Door 2	Clearance Door 1	Clearance Door 2
36 x 48	54 ³ / ₈ "	55"	28 ¹ / ₂ "	30 ³ / ₄ "	33 ³ / ₈ "	32 ¹ / ₈ "	32 ¹ / ₈ "
36 x 60	54 ³ / ₈ "	67"	33 ¹ / ₂ "	30 ³ / ₄ "	45 ³ / ₈ "	32 ¹ / ₈ "	32 ¹ / ₈ "
40 x 54	58 ³ / ₈ "	61"	30 ¹ / ₂ "	34 ³ / ₄ "	39 ³ / ₈ " †35 ¹ / ₂ "	35 ¹ / ₈ "	32 ¹ / ₈ "

† Dimension when car gate is mounted opposite side from what is shown.

Type 4 - Car with Standard Pocket Gate

Pocket gate only available with gate stack on rail side.

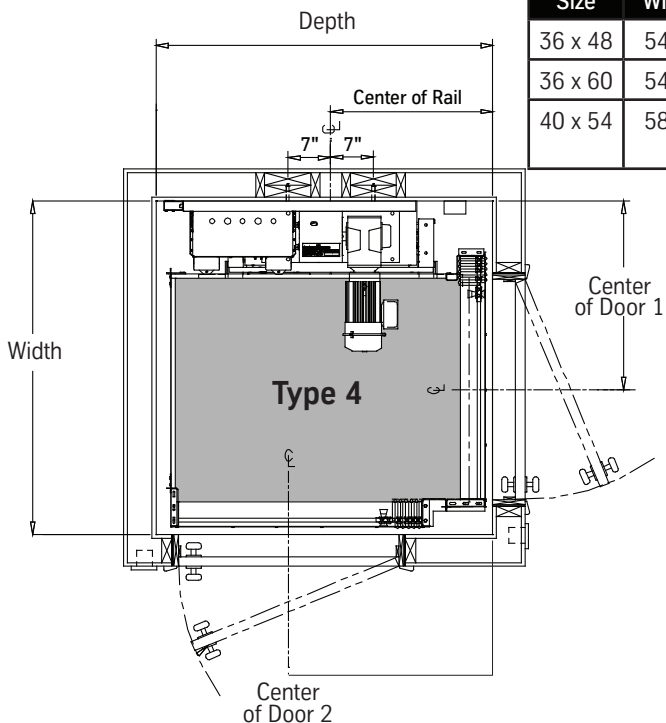

Car Size	Width	Depth	Center of Rail	Center of Door 1	Center of Door 2	Clearance Door 1	Clearance Door 2
36 x 48	54 ³ / ₈ "	55"	26 ¹ / ₂ "	30 ³ / ₄ "	33 ³ / ₈ "	32 ¹ / ₈ "	32 ¹ / ₈ "
36 x 60	54 ³ / ₈ "	67"	33 ¹ / ₂ "	30 ³ / ₄ "	45 ³ / ₈ "	32 ¹ / ₈ "	32 ¹ / ₈ "
40 x 54	58 ³ / ₈ "	61"	30 ¹ / ₂ "	34 ³ / ₄ "	39 ³ / ₈ " †35 ¹ / ₂ "	35 ¹ / ₈ "	32 ¹ / ₈ "

† Dimension when car gate is mounted opposite side from what is shown.

Note:

All dimensions are to inside finished walls.

All hoistway sizes shown are for use with standard electromechanical interlocks.

Hoistway sizes change when using optional G.A.L. interlocks. For G.A.L. dimensions and more detailed information of all hoistway sizes, go to: www.tkaccess.com/levhoistway

Hoistway Construction: Type 1 Cars - Enter/Exit Same Side with Optional Non-Pocketed Gate

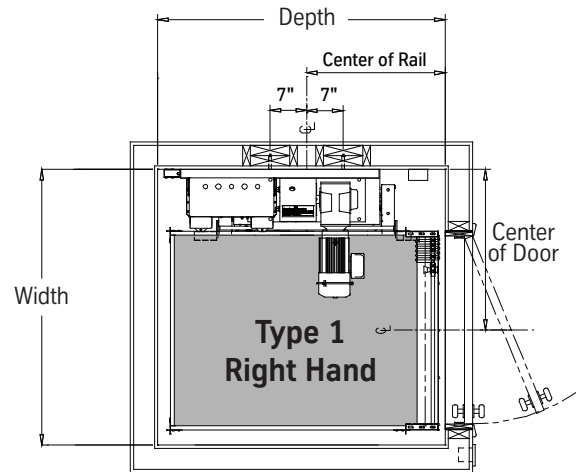
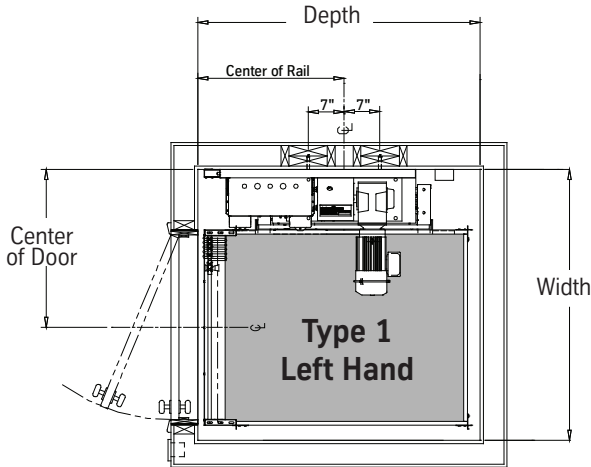

Car Size	Width	Depth	Center of Rail	Center of Door	Clear Opening
36 x 48	52 ³ / ₄ "	55"	28 ¹ / ₂ "	30 ³ / ₄ "	28 ⁵ / ₈ "
36 x 60	52 ³ / ₄ "	67"	33 ¹ / ₂ "	30 ³ / ₄ "	28 ⁵ / ₈ "
40 x 54	56 ³ / ₄ "	61"	30 ¹ / ₂ "	34 ³ / ₄ " †30 ³ / ₄ "	32 ¹ / ₈ "

Car Size	Width	Depth	Center of Rail	Center of Door	Clear Opening
36 x 48	52 ³ / ₄ "	55"	26 ¹ / ₂ "	30 ³ / ₄ "	28 ⁵ / ₈ "
36 x 60	52 ³ / ₄ "	67"	33 ¹ / ₂ "	30 ³ / ₄ "	28 ⁵ / ₈ "
40 x 54	56 ³ / ₄ "	61"	30 ¹ / ₂ "	34 ³ / ₄ " †30 ³ / ₄ "	32 ¹ / ₈ "

Note:
All dimensions are to inside finished walls.

† Dimension when car gate is mounted opposite side from what is shown.

Hoistway Construction: Type 2 Car - Straight-Thru with Optional Non-Pocketed Gates

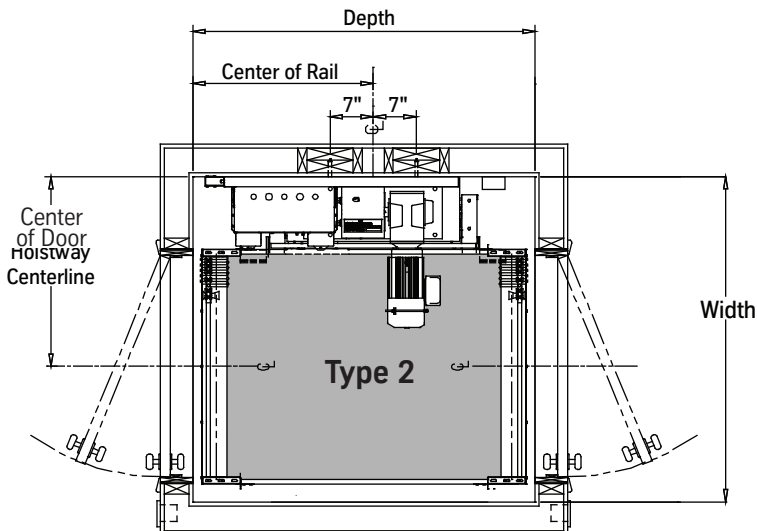

Car Size	Width	Depth	Center of Rail	Center of Door	Clear Opening
36 x 48	52 ³ / ₄ "	55 ¹ / ₂ "	29 ¹ / ₄ "	30 ³ / ₄ "	28 ⁵ / ₈ "
36 x 60	52 ³ / ₄ "	67 ¹ / ₂ "	33 ³ / ₄ "	30 ³ / ₄ "	28 ⁵ / ₈ "
40 x 54	56 ³ / ₄ "	61 ¹ / ₂ "	30 ³ / ₄ "	34 ³ / ₄ " †30 ³ / ₄ "	32 ¹ / ₈ "

† Dimension when car gate is mounted opposite side from what is shown.

Note:
All dimensions are to inside finished walls.

All hoistway sizes shown are for use with standard electromechanical interlocks. Hoistway sizes change when using optional G.A.L. interlocks. For G.A.L. dimensions and more detailed information of all hoistway sizes, go to: www.tkaccess.com/levhoistway

Hoistway Construction: Type 3 & 4 Cars - Enter/Exit 90° Side with Optional Non-Pocketed Gates

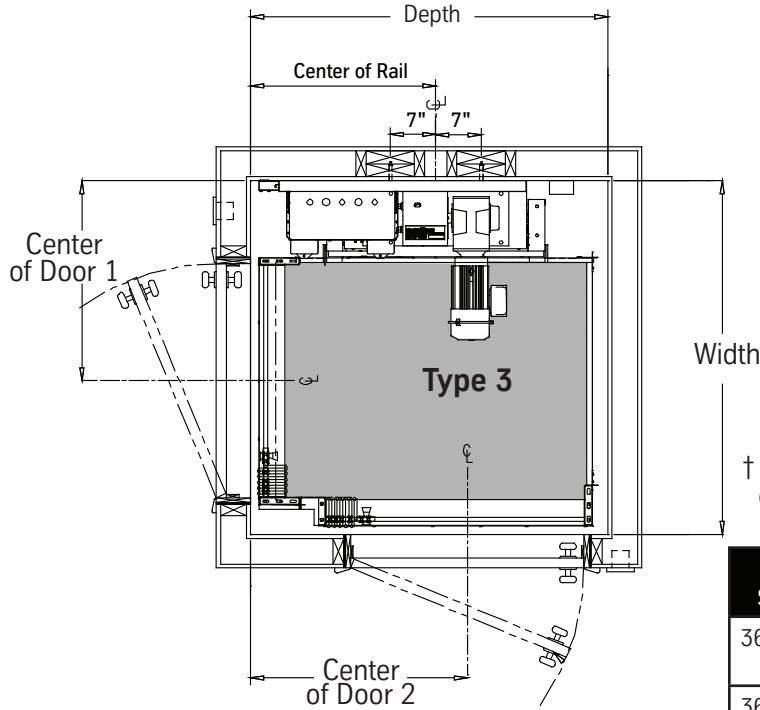

Note:
All dimensions are to inside finished walls.

† Dimension when car gate is mounted opposite side from what is shown.

Car Size	Width	Depth	Center of Rail	Center Door 1	Center Door 2	Clear Opening
36 x 48	54 ³ / ₈ "	55"	28 ¹ / ₂ "	30 ³ / ₄ " †30 ³ / ₄ "	33 ³ / ₈ " †29 ¹ / ₂ "	28 ⁵ / ₈ "
36 x 60	54 ³ / ₈ "	67"	33 ¹ / ₂ "	30 ³ / ₄ " †30 ³ / ₄ "	45 ³ / ₈ " †41 ¹ / ₂ "	28 ⁵ / ₈ "
40 x 54	58 ³ / ₈ "	61"	30 ¹ / ₂ "	30 ³ / ₄ " †34 ³ / ₄ "	39 ³ / ₈ " †35 ¹ / ₂ "	32 ¹ / ₈ "

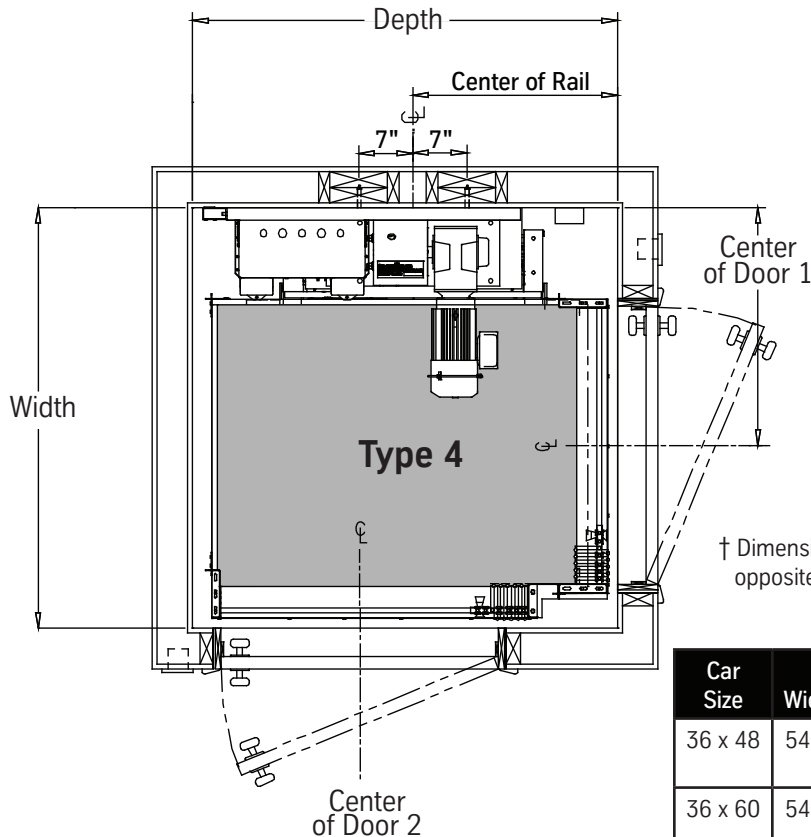

Note:
All dimensions are to inside finished walls.

† Dimension when car gate is mounted opposite side from what is shown.

Car Size	Width	Depth	Center of Rail	Center Door 1	Center Door 2	Clear Opening
36 x 48	54 ³ / ₈ "	55"	26 ¹ / ₂ "	30 ³ / ₄ " †30 ³ / ₄ "	33 ³ / ₈ " †29 ¹ / ₂ "	28 ⁵ / ₈ "
36 x 60	54 ³ / ₈ "	67"	33 ¹ / ₂ "	30 ³ / ₄ " †30 ³ / ₄ "	45 ³ / ₈ " †41 ¹ / ₂ "	28 ⁵ / ₈ "
40 x 54	58 ³ / ₈ "	61"	30 ¹ / ₂ "	30 ³ / ₄ " †34 ³ / ₄ "	39 ³ / ₈ " †35 ¹ / ₂ "	32 ¹ / ₈ "

Hoistway Construction: Type 5 Cars - Enter/Exit Adjacent Side with Non-Pocketed Gate

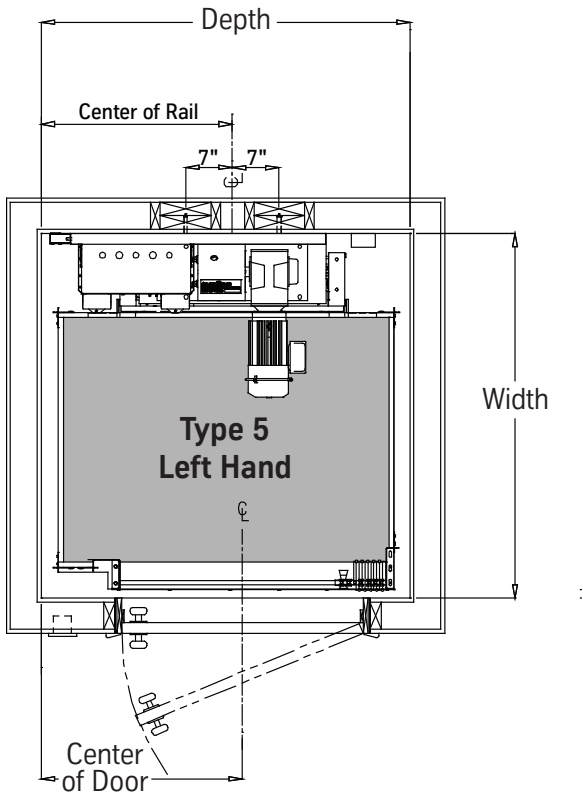

Note:

All dimensions are to inside finished walls.

† Dimension when car gate is mounted opposite side from what is shown.

Car Size	Width	Depth	Center of Rail	Center of Door	Clear Opening
36 x 48	54 ³ / ₈ "	55"	28 ¹ / ₂ "	30" †33 ¹ / ₂ "	32 ¹ / ₈ "
36 x 60	54 ³ / ₈ "	67"	33 ¹ / ₂ "	42" †47 ¹ / ₂ "	32 ¹ / ₈ "
40 x 54	58 ³ / ₈ "	61"	30 ¹ / ₂ "	36" †39 ¹ / ₂ "	32 ¹ / ₈ "

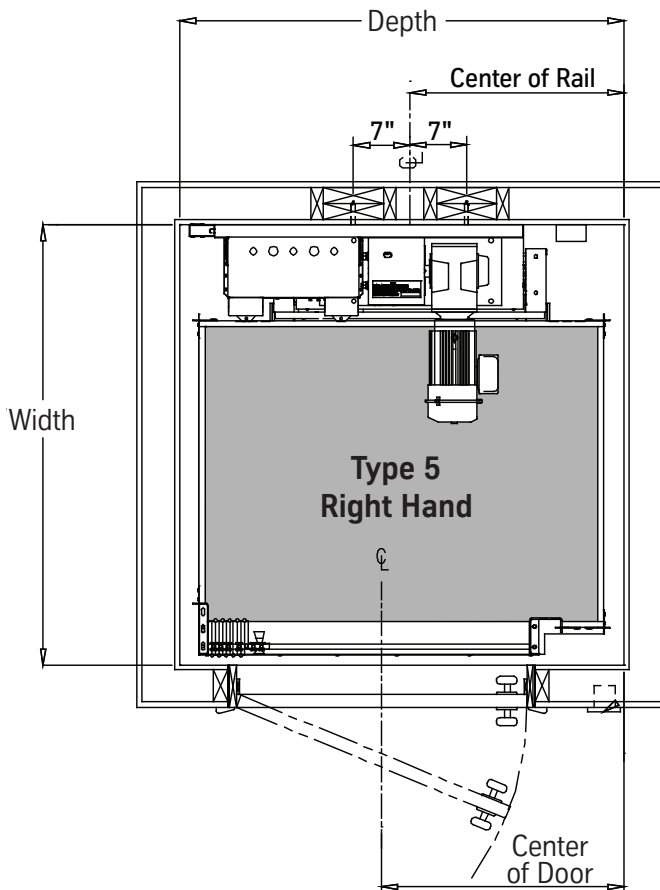

Note:

All dimensions are to inside finished walls.

† Dimension when car gate is mounted opposite side from what is shown.

Car Size	Width	Depth	Center of Rail	Center of Door	Clear Opening
36 x 48	54 ³ / ₈ "	55"	26 ¹ / ₂ "	30" †33 ¹ / ₂ "	32 ¹ / ₈ "
36 x 60	54 ³ / ₈ "	67"	33 ¹ / ₂ "	42" †47 ¹ / ₂ "	32 ¹ / ₈ "
40 x 54	58 ³ / ₈ "	61"	30 ¹ / ₂ "	36" †39 ¹ / ₂ "	32 ¹ / ₈ "

Hoistway Construction Notes

- Also see Drive Unit Area Construction Details on pages 14 and 15.
- A load bearing wall is required to sustain rail reactions.
See Rail Reactions and Guide Rail Backing Construction below.
- All points of the pit floor must be a minimum of 6" below the lower landing finished floor.
- Pit floor construction should withstand a 3200 lb. impact load.
- Hoistway sizes reflect running and access clearances only. *Consult your local authority to assure compliance with state and local codes.*
- Minimum overhead clearance is 9'-0" above the top landing finished floor. *(Optional 88" car height requires 9'-4", 94" car height requires 9'-10").*
- Due to limited clearances, it is imperative that the walls are square and plumb throughout the hoistway. The finished hoistway must be within 1/4" tolerance from top to bottom.
- Hoistway door provided by others. *We recommend a 3'-0" x 6'-8" door.*
- Hoistway is required to be free of all pipes, wiring and obstructions not related to the operation of the elevator.
- Service access hatch is required in the controller / drive assembly area. *See page 14 or 15 for recommended location.*
- Building structure must provide for a means of a chain hoist for hoisting rail and elevator materials to the top of the hoistway during installation.

Guide Rail Backing Construction Details:

- Rail backing consists of two (2) rails, mounted 14" apart at center. Follow the instructions below for each separate rail.
- Laminate (2) 2x8's and (2) 2x4's with glue and #8 x 2 1/4" wood screws (minimum).
- Overlap joints of the lumber as necessary for structural rigidity.
- Guide rail backing must be tied to a horizontal structural member (header or floor plate) at top, bottom and a maximum of 10' between.

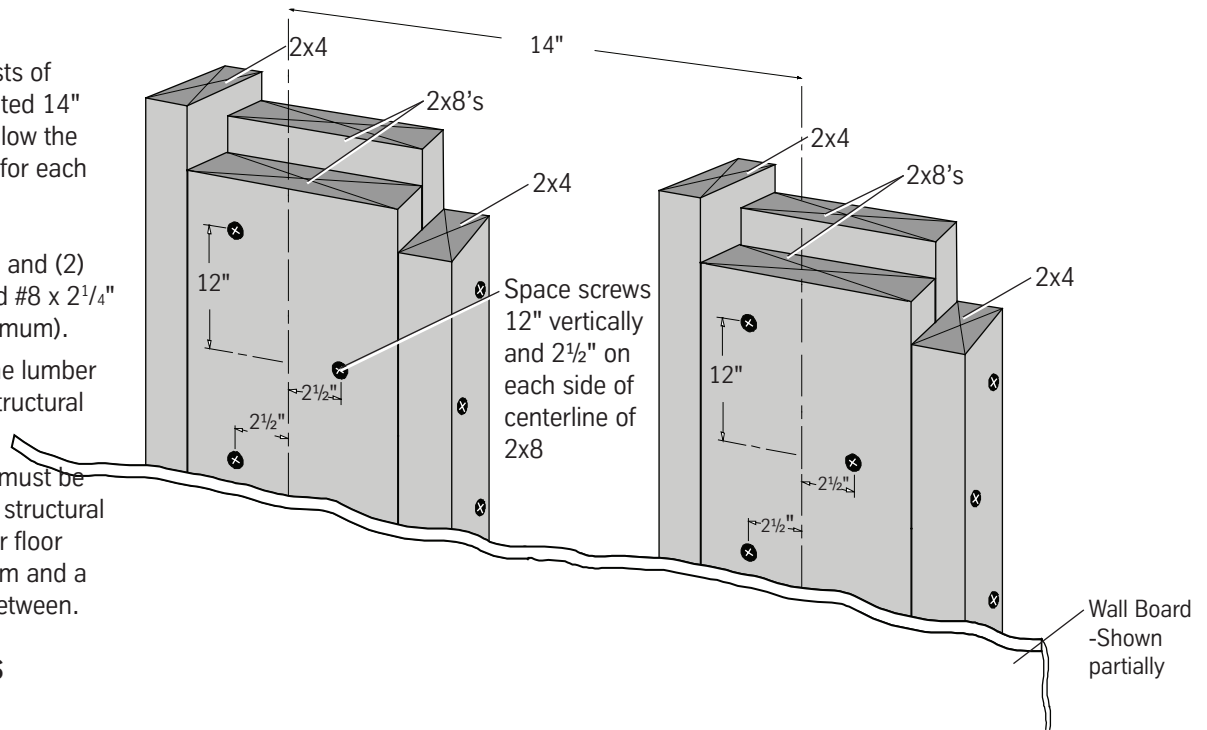

Rail Reactions

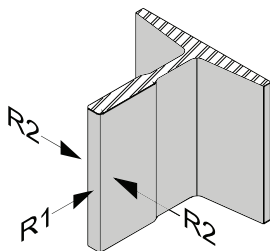

R1 = 210 LBF.

R2 = 543 LBF.

Rail reactions do not include safety factors. Applicable safety factors must be considered in hoistway design.

Wall attachment pull-out force is 147 LBF. per fastener.

Typical Counterweight Chain Drive Unit Area Construction Details:

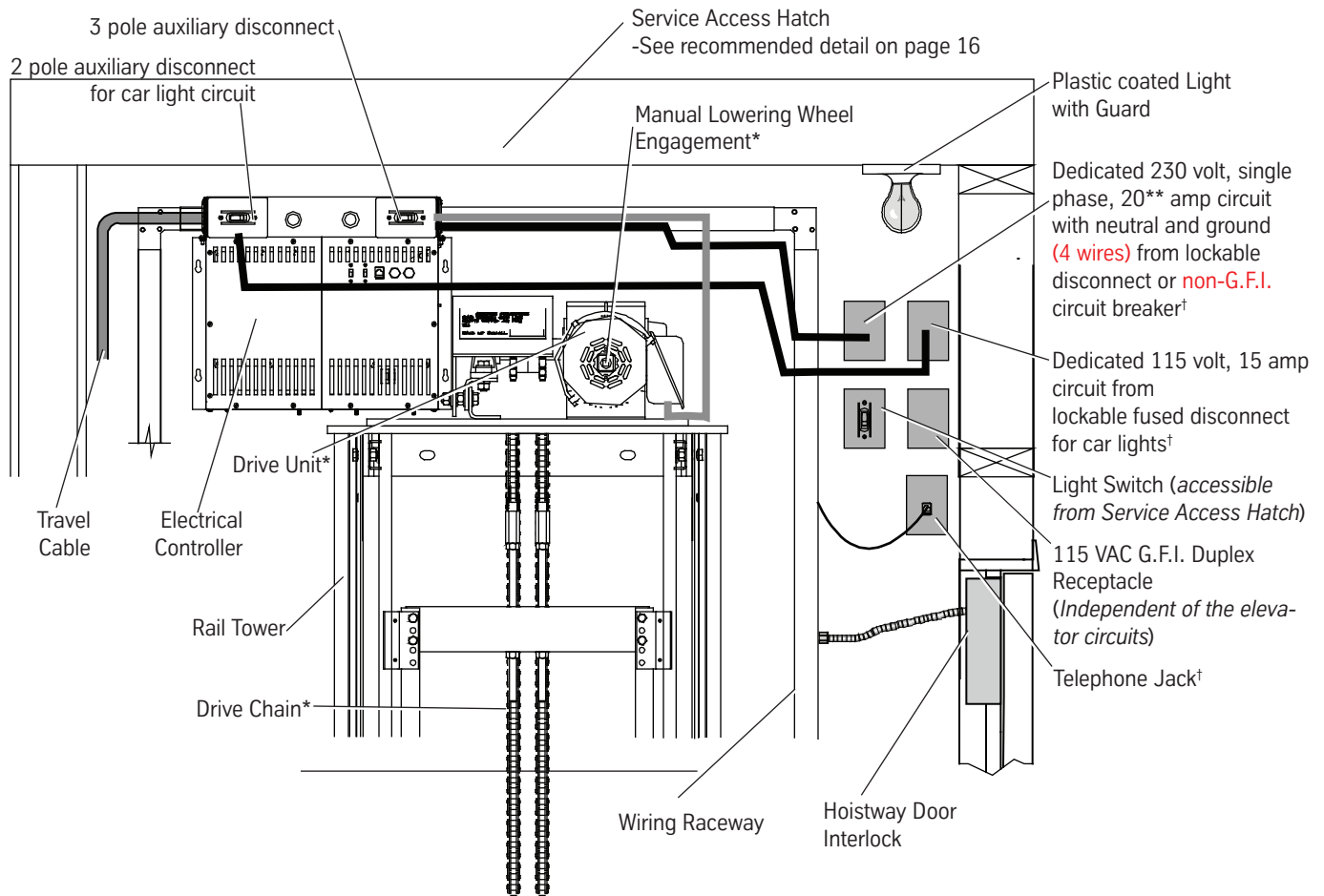

Section thru Top of Hoistway

† If the elevator controller is installed in a remote machine room, these items are to be provided in the machine room, near the controller.

Construction Notes:

- Minimum overhead clearance for standard car is 9'-0" above the top landing finished floor.
- Light, light switch, receptacle, incoming electrical circuits and telephone jack to be located within 6¹/₂" of the hoistway door wall to avoid interference with wiring raceway (or may be located in ceiling).

Optional Counterweighted Chain Drive Unit Area Construction Details with Remote Located Electrical Controller:

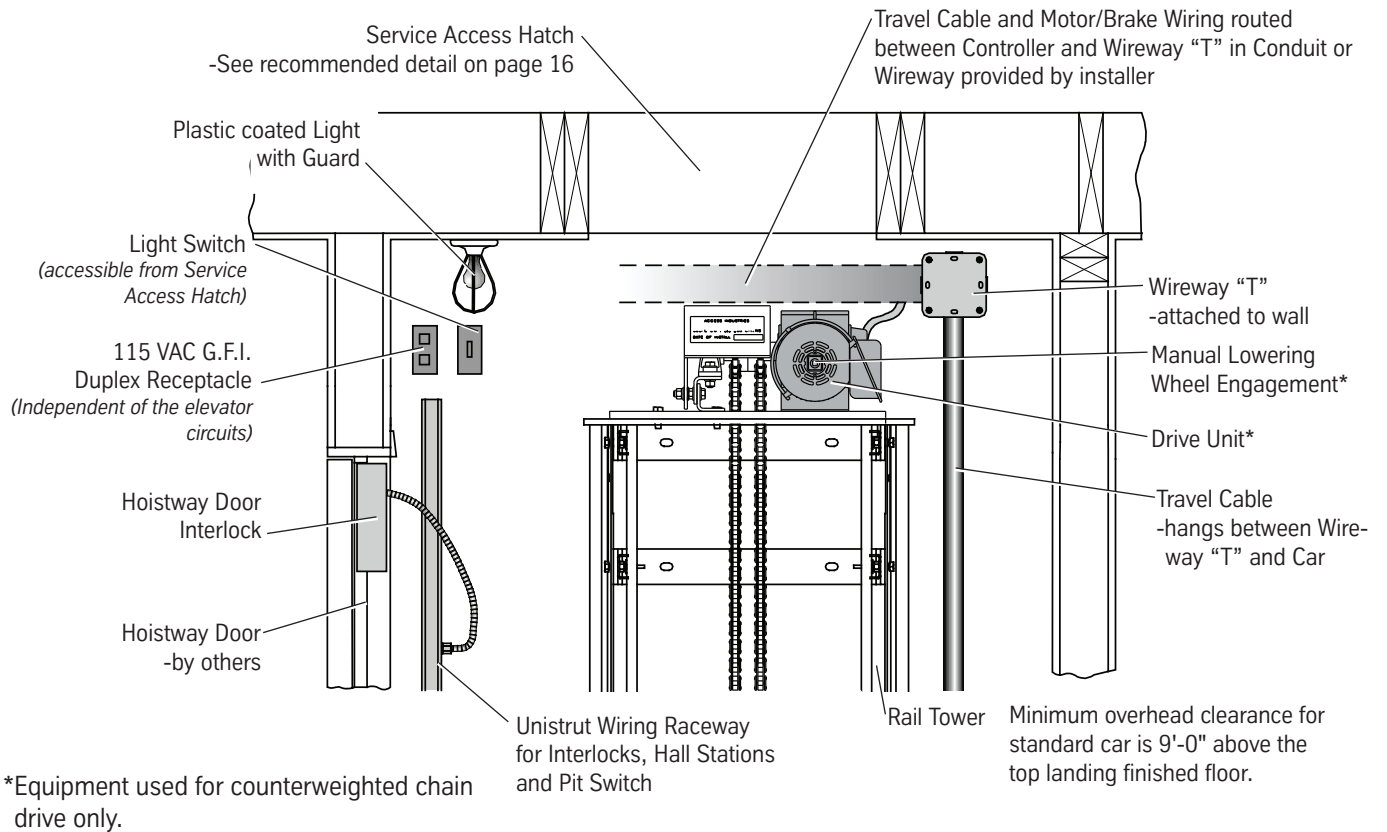

Section thru Top of Hoistway at Drive Unit

Requirements for Counterweighted Chain Drive Remote Located Electrical Controller:

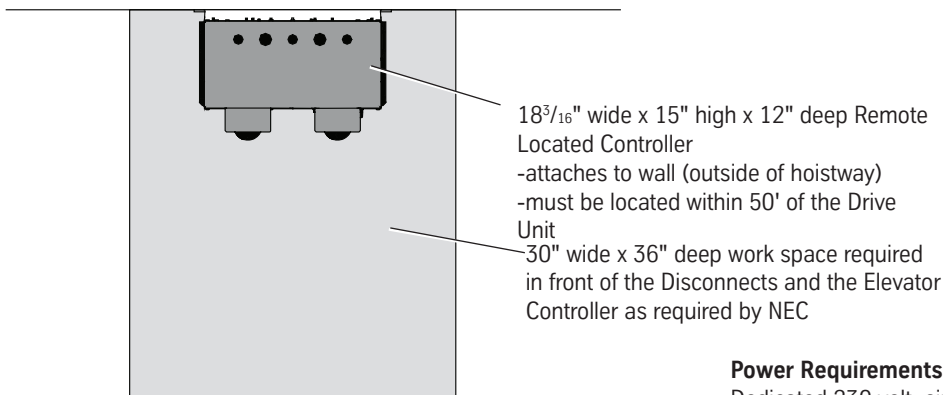

Plan View of Controller Area

Power Requirements:

Dedicated 230 volt, single phase, 20** amp circuit with neutral and ground (4 wires) from lockable disconnect or non-G.F.I. circuit breaker.

Dedicated 115 volt, 15 amp circuit from lockable fused disconnect for car lights.

Telephone circuit.

**30 amp circuit required for hydraulic drive.

Service Access Hatch

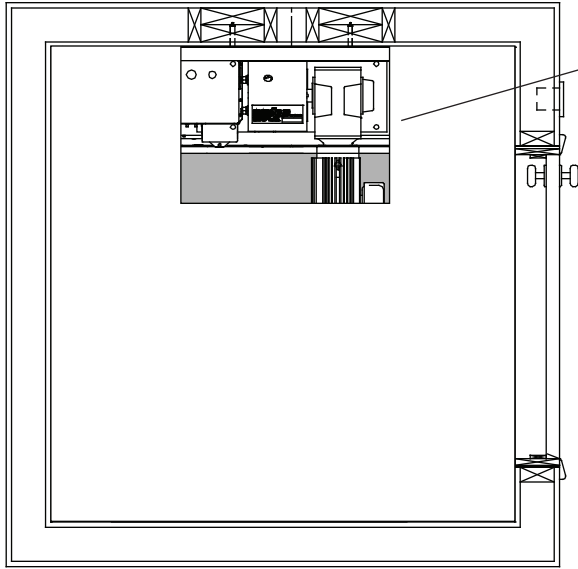

Plan View

18" x 24" minimum hatch opening above the controller and drive assemblies

- This is the recommended location of the access hatch. If sufficient attic space is not available, access through a wall must be provided. *Cannot be through the rail wall (contact factory for alternatives).*
- Construction of access hatch and door is by others.
- Door needs to be self closing and lockable.

Description of Features:

Car Operating Panel



Used to control the elevator from inside the car.

- Automatic car controls; buttons illuminate when call is registered.
- LED floor position display with system diagnostics that alerts the homeowner of complications that the control system may see.
- Emergency stop switch.
- Emergency alarm switch. Battery powered during power failure.
- Battery backup emergency light, integrated into the top of the panel, illuminates during power failure.
- In case of power failure, the elevator can be lowered to another landing.
- Light switch to override the automatic car lights.
- Optional key switch available to limit access to authorized persons.
- Standard brushed stainless steel or brushed brass face. Also available in polished stainless steel or polished brass.

Hall Stations



Used to call the elevator to your floor.

- Automatic control.
- LED floor position display with system diagnostics that alerts the homeowner of complications that the control system may see.
- One provided for each floor level. Additional hall stations available for more than one opening per floor level.
- Standard brushed stainless steel or brushed brass face. Also available in polished stainless steel or polished brass.
- Optional key switch available to limit access to authorized persons.

Recessed Telephone Cabinet (optional)



Conceals standard telephone.

- Standard brushed stainless steel or brass door. Also, available in polished stainless steel or brass.
- Telephone circuit is required to be provided in the area of the elevator controller.
- If the telephone cabinet is not selected, a telephone is provided for surface mounting inside the car.

Electrical Controller



Controls the electrical operation of the elevator.

- Located in the top of the hoistway near the drive unit.
- Programmable Logic Controller (PLC) with digital signal processor allows for SoftStart and SoftStop technology.
- Includes uninterruptible power supply (UPS) for floor selectable automatic lowering and operation of automatic car gate (if equipped). In case of power failure, the elevator can be lowered to another landing.
- Includes run/stop switch, automatic/remote switch and plug for construction/inspection pendant control.
- Can be located in a remote machine room for areas that do not allow the electrical controller to be located inside the hoistway.

Hoistway Door Interlocks



Locks the hoistway door when the car is not there.

- Surface mounted electromechanical interlock.
- Can be opened with a special key from outside the hoistway in case of emergency or for servicing.

Car Lights



Two recessed halogen car lights provided.

- Provided with stainless steel bezels.
- Automatically turns on when gate is opened and turns off 5 minutes after the elevator is used.
- Switch is provided on the car operating panel to provide constant on lights.
- Separate battery backup emergency light is integrated in the car operating panel that illuminates during power failure.
- As an option, wiring can be provided to the car top for connection to consumer provided lights.

Description of Features continued:

Automatic Car Gate Operator (optional)



Automatically opens the car gate when car stops at a floor.

- Mounts to top of car.
- Includes light beam safety curtain to keep gate open until path is clear.
- Closing speed slows the gate before full close.
- If car is already at floor level, the gate automatically opens when the hoistway door is opened.
- A door open button is provided on the car operating panel.

Auto-Opener™ (optional)



Automatically opens hoistway door when car stops at a floor.

- Mounts to wall near top of door on the hinge side. Backing is required by contractor.
- Works in conjunction with the automatic car gate operator.
- Automatically reverses when an obstruction is encountered.
- If car is already at floor level, door can be opened by pressing hall station button.
- Requires 115 VAC outlet near the top of the door on the hinge side at each landing.

Safety Devices

- Automatic bi-directional leveling. The elevator slows to a smooth stop.
- Terminal limits. Stops the elevator if it overruns the normal limits at the top or bottom landing.
- Final limits. A redundant safety feature if the elevator overruns the terminal limits at the top or bottom, the final limit stops the elevator and renders all automatic controls inoperable. If this happens, the elevator must be serviced to determine and correct the fault.
- Pit switch and car top switch. Disables elevator for servicing purposes.
- Interlocks. Hoistway doors remain locked when the car is not at that floor and prevent the elevator from running until all doors are closed.
- Slack chain device. In the unlikely event that a drive chain would slacken or break, the device locks the car onto the T-rails, preventing the car from falling.
- Car emergency stop switch. Located on car operating panel. Manual toggle switch disables elevator from inside car.

SECTION 14235
Residential Elevators**PART 1 GENERAL****1.01 SUMMARY**

- A. The product described herein, manufactured by ThyssenKrupp Access, is a private residence home elevator designed and dimensioned to provide access to all levels to the home based on the individual's requirements.

1.02 REFERENCES

- A. Elevator shall be designed, manufactured and installed in accordance with the following standards:
1. American National Standards Institute (ANSI).
 2. American Society of Mechanical Engineers (ASME).
 3. International Building Code (IBC).
 4. National Electrical Code (NEC).
 5. American Society for Testing Materials (ASTM).
 6. American Welding Society (AWS).

1.03 SYSTEM DESCRIPTION

- A. Drive System: Geared machine with counterweighted chain drive and frequency controlled variable speed drive, 2 hp motor. Programmable logic controller with digital signal processor with automatic operation.
- B. Number of Stops: (specify:) Two to five.
- C. Car Configuration: (specify:) straight-thru, 90° side exit or enter/exit same side.
- D. Maximum Travel: (specify:) Up to 50'.
- E. Rated Load: (specify:) 700, 750 or 950 lbs.
- F. Rated Speed: 40 fpm.
- G. Car Size:
1. (specify:) 36"x48", 36"x60" or 40"x54" platform.
 2. (specify:) 84", 88" or 94" high ceiling.
- H. Car Walls: (specify:) Melamine panels (champagne, light oak, dark oak or white), wood veneer panels, inset wood veneer panels, or raised wood panels (oak, cherry, maple or birch).
- I. Car Ceiling: (specify:) White or wood veneer to match wall panels.
- J. Car Lighting: Two recessed halogen lamps with stainless steel bezel.
- K. Handrail: (specify:) To match wall panels, brass (brushed or polished), or stainless steel (brushed or polished).
- L. Operating Features:
1. Car Operating Panel: (specify:) Stainless steel or brass (brushed or polished) panel with illuminated automatic controls, light switch, emergency stop switch, alarm button and LED floor position/diagnostic display, and (specify option:) key lock.
 2. Hall Stations: (specify:) Stainless steel or brass (brushed or polished) panel illuminated button, LED position/diagnostic display and (specify option:) key lock provided at each landing.
 3. Pit Switch and car top run/stop switch.
 4. Uninterruptible power supply (UPS) for lowering and automatic gate operation (if equipped) in the event of a power failure.
 5. Automatic homing to (specify) floor.
 6. Surface mounted telephone inside car.
 7. Car Gate(s): Accordion folding gate with safety switch (specify color:) champagne, chalk, white, light oak, dark oak, or clear panels.
 8. Hoistway Door Interlocks: (specify:) Electromechanical interlocks or G.A.L. interlocks with retiring cam if necessary.
 9. Upper and lower terminal limits.
 10. Final limits (2 upper and 1 lower).
 11. Slack chain safety.
 12. Drive circuit disconnect box (with auxiliary contacts) at controller.
 13. Light circuit disconnect box at controller.
 14. Battery backup emergency light and alarm.
 15. (specify option:) Recessed telephone cabinet.
 16. (specify option:) Automatic gate operator(s) with light beam safety curtain.
 17. (specify option:) Counterweight safety device.
 18. (specify option:) Buffer springs (requires 12" pit).

1.04 QUALITY ASSURANCE

- A. Manufacturer: Provide elevator manufactured by a firm with a minimum of 10 years experience in fabrication of elevators equivalent to those specified.
- B. All designs, clearances, workmanship and material, unless specifically accepted, shall be in accordance with all codes having legal jurisdiction.
- C. All load ratings and safety factors shall meet or exceed those specified by all governing agencies with jurisdiction and shall be certified by a professional engineer.
- D. Elevator shall be subject to applicable state, local and city approval prior to installation and subject to inspection after installation. Determination of and adherence to these regulations is the responsibility of the elevator contractor.
- E. Welders certified in accordance with requirements of AWS D1.1 shall perform all welding of all parts.
- F. Substitutions: No substitutions permitted.

1.05 WARRANTY

- A. Warranty: Manufacturer shall warrant component parts of the Lev® home elevator for a period of two years after installation.

1.06 MAINTENANCE

- A. The Lev® home elevator must be maintained in accordance with manufacturer's instructions.

PART 2 PRODUCT**2.01 MANUFACTURER**

- A. Provide the Lev® home elevator manufactured by ThyssenKrupp Access Manufacturing LLC.
1. Contact: 4001 E. 138th Street, Grandview, MO
Telephone: 800-925-3100; Fax: 816-763-4467
Email: archassist@tkaccess.com
Web site: www.thelev.com
Web site: www.tkaccess.com

2.02 MATERIAL

- A. Guide Rail: Dual 6³/₄ lbs. modular machined steel T-rail system.
- B. Chain: Two #60 roller chains.
- C. Sling: 1/4" and 12 ga. structural and formed steel plates.
- D. Platform Floor: Unfinished plywood with removable insert for 3/4" flooring.

2.03 FINISHES

- A. Components shall be prepared with 1)alkaline detergent wash, 2)clear water rinse, 3)iron phosphate coating, 4)clear water rinse and finished with electrostatically applied and baked thermostatic powder coat finish for indoor or outdoor use. Standard color is ivory.

2.04 ELECTRICAL SYSTEMS

- A. The electrical contractors shall provide:
1. 230 VAC, 20 amp, 60 Hz, single phase power source with neutral and ground (4 wires) in the controller area.
 2. 115 VAC, single phase, 20 amp, 60 Hz power circuit in the controller area for the car lights.
 3. Telephone circuit in the controller area.

PART 3 EXECUTION

3.01 ACCEPTABLE INSTALLERS

- A. Installers shall be experienced in performing work of this section who have specialized in work comparable to that required for this project.
- B. Installers shall be certified and trained by the manufacturer.

3.02 EXAMINATION

- A. Use field dimensions and approved manufacturer's shop drawings to examine substrates, supports and other conditions under which this work is to be performed. Do not proceed with work until unsatisfactory conditions are corrected.

3.03 INSTALLATION

- A. The Lev® home elevator shall be installed in accordance with manufacturer's instructions and as specified and approved by architect.
- B. Hoistway doors shall be installed by others.

3.04 DEMONSTRATION

- A. The elevator contractor shall make a final check of the elevator's operation with the Owner or Owner's representative present prior to turning the elevator over for use. The elevator contractor shall determine that operating and safety devices are functioning properly.

END OF SECTION

Notes: Intent of specification is to broadly outline equipment required but does not cover details of design and construction.

Dimensions and specifications are subject to constant change and continually evolving codes and product applications. For additional technical information, contact ThyssenKrupp Access Manufacturing LLC at (800) 925-3100 or www.tkaccess.com.

(continued on next page)



Lev Home Elevator with Signet Cab (Counterweighted Chain Drive)

SECTION 14235 Residential Elevators

PART 1 GENERAL

1.01 SUMMARY

- A. The product described herein, manufactured by ThyssenKrupp Access, is a private residence home elevator designed and dimensioned to provide access to all levels to the home based on the individual's requirements.

1.02 REFERENCES

- A. Elevator shall be designed, manufactured and installed in accordance with the following standards:
1. American National Standards Institute (ANSI).
 2. American Society of Mechanical Engineers (ASME).
 3. International Building Code (IBC).
 4. National Electrical Code (NEC).
 5. American Society for Testing Materials (ASTM).
 6. American Welding Society (AWS).

1.03 SYSTEM DESCRIPTION

- A. Drive System: Geared machine with counterweighted chain drive and frequency controlled variable speed drive, 2 hp motor. Programmable logic controller with digital signal processor with automatic operation.
- B. Number of Stops: (specify:) Two to five.
- C. Car Configuration: (specify:) straight-thru, 90° side exit or enter/exit same side.
- D. Maximum Travel: (specify:) Up to 50'.
- E. Rated Load: (specify:) 700, 750 or 950 lbs.
- F. Rated Speed: 40 fpm.
- G. Car Size:
1. (specify:) 36"x48", 36"x60" or 40"x54" platform.
 2. (specify:) 84", 88" or 94" high ceiling.
- H. Car Walls: (specify:) Metal frame with upper panel of glass, metal, laminate, stone or wood, lower panel of glass, metal, laminate, stone or wood.
- I. Car Ceiling: (specify:) Custom metal, laminate or wood.
- J. Car Lighting: (specify:) Two or four halogen lamps.
- K. Handrail: (specify:) Stainless steel or bronze (polished, brushed or decorative).
- L. Operating Features:
1. Car Operating Panel: (specify:) custom metal, laminate or wood full length panel with flush mounted illuminated automatic controls, light switch, emergency stop switch, alarm button and LED floor position/diagnostic display, and (specify option:) key lock.
 2. Hall Stations: (specify:) Stainless steel or brass (brushed or polished) panel illuminated button, LED position/diagnostic display and (specify option:) key lock provided at each landing.
 3. Pit Switch and car top run/stop switch.
 4. Uninterruptible power supply (UPS) for lowering and automatic gate operation in the event of a power failure.
 5. Automatic homing to (specify) floor.
 6. Telephone inside recessed telephone cabinet in car.
 7. Car Gate(s): Accordion folding gate with safety switch (specify color:) champagne, chalk, white, light oak, dark oak, or clear panels.
 8. Hoistway Door Interlocks: (specify:) Electromechanical interlocks or G.A.L. interlocks with retiring cam if necessary.
 9. Upper and lower terminal limits.
 10. Final limits (2 upper and 1 lower).
 11. Slack chain safety.
 12. Drive circuit disconnect box (with auxiliary contacts) at controller.

13. Light circuit disconnect box at controller.
14. Battery backup emergency light and alarm.
15. Recessed telephone cabinet.
16. Automatic gate operator(s) with light beam safety curtain.
17. (specify option:) Counterweight safety device.
18. (specify option:) Buffer springs (requires 12" pit).

1.04 QUALITY ASSURANCE

- A. Manufacturer: Provide elevator manufactured by a firm with a minimum of 10 years experience in fabrication of elevators equivalent to those specified.
- B. All designs, clearances, workmanship and material, unless specifically accepted, shall be in accordance with all codes having legal jurisdiction.
- C. All load ratings and safety factors shall meet or exceed those specified by all governing agencies with jurisdiction and shall be certified by a professional engineer.
- D. Elevator shall be subject to applicable state, local and city approval prior to installation and subject to inspection after installation. Determination of and adherence to these regulations is the responsibility of the elevator contractor.
- E. Welders certified in accordance with requirements of AWS D1.1 shall perform all welding of all parts.
- F. Substitutions: No substitutions permitted.

1.05 WARRANTY

- A. Warranty: Manufacturer shall warrant component parts of the Lev® Signet home elevator for a period of two years after installation.

1.06 MAINTENANCE

- A. The Lev® Signet home elevator must be maintained in accordance with manufacturer's instructions.

PART 2 PRODUCT

2.01 MANUFACTURER

- A. Provide the Lev® Signet home elevator manufactured by ThyssenKrupp Access Manufacturing LLC.
1. Contact: 4001 E. 138th Street, Grandview, MO
Telephone: 800-925-3100; Fax: 816-763-4467
Email: archassist@tkaccess.com
Web site: www.thelev.com
Web site: www.tkaccess.com

2.02 MATERIAL

- A. Guide Rail: Dual 6^{1/4} lbs. modular machined steel T-rail system.
- B. Chain: Two #60 roller chains.
- C. Sling: 1/4" and 12 ga. structural and formed steel plates.
- D. Platform Floor: Unfinished plywood with removable insert for 3/4" flooring.

2.03 FINISHES

- A. Components shall be prepared with 1)alkaline detergent wash, 2)clear water rinse, 3)iron phosphate coating, 4)clear water rinse and finished with electrostatically applied and baked thermostatic powder coat finish for indoor or outdoor use. Standard color is ivory.

(continued on next page)



2.04 ELECTRICAL SYSTEMS

- A. The electrical contractors shall provide:
 - 1. 230 VAC, 20 amp, 60 Hz, single phase power source with neutral and ground (4 wires) in the controller area.
 - 2. 115 VAC, single phase, 20 amp, 60 Hz power circuit in the controller area for the car lights.
 - 3. Telephone circuit in the controller area.

PART 3 EXECUTION

3.01 ACCEPTABLE INSTALLERS

- A. Installers shall be experienced in performing work of this section who have specialized in work comparable to that required for this project.
- B. Installers shall be certified and trained by the manufacturer.

3.02 EXAMINATION

- A. Use field dimensions and approved manufacturer's shop drawings to examine substrates, supports and other conditions under which this work is to be performed. Do not proceed with work until unsatisfactory conditions are corrected.

3.03 INSTALLATION

- A. The Lev® Signet home elevator shall be installed in accordance with manufacturer's instructions and as specified and approved by architect.
- B. Hoistway doors shall be installed by others.

3.04 DEMONSTRATION

- A. The elevator contractor shall make a final check of the elevator's operation with the Owner or Owner's representative present prior to turning the elevator over for use. The elevator contractor shall determine that operating and safety devices are functioning properly.

END OF SECTION

Notes: Intent of specification is to broadly outline equipment required but does not cover details of design and construction.

Dimensions and specifications are subject to constant change and continually evolving codes and product applications. For additional technical information, contact ThyssenKrupp Access at (800) 925-3100 or www.tkaccess.com.

Counterweighted Chain Drive Overview

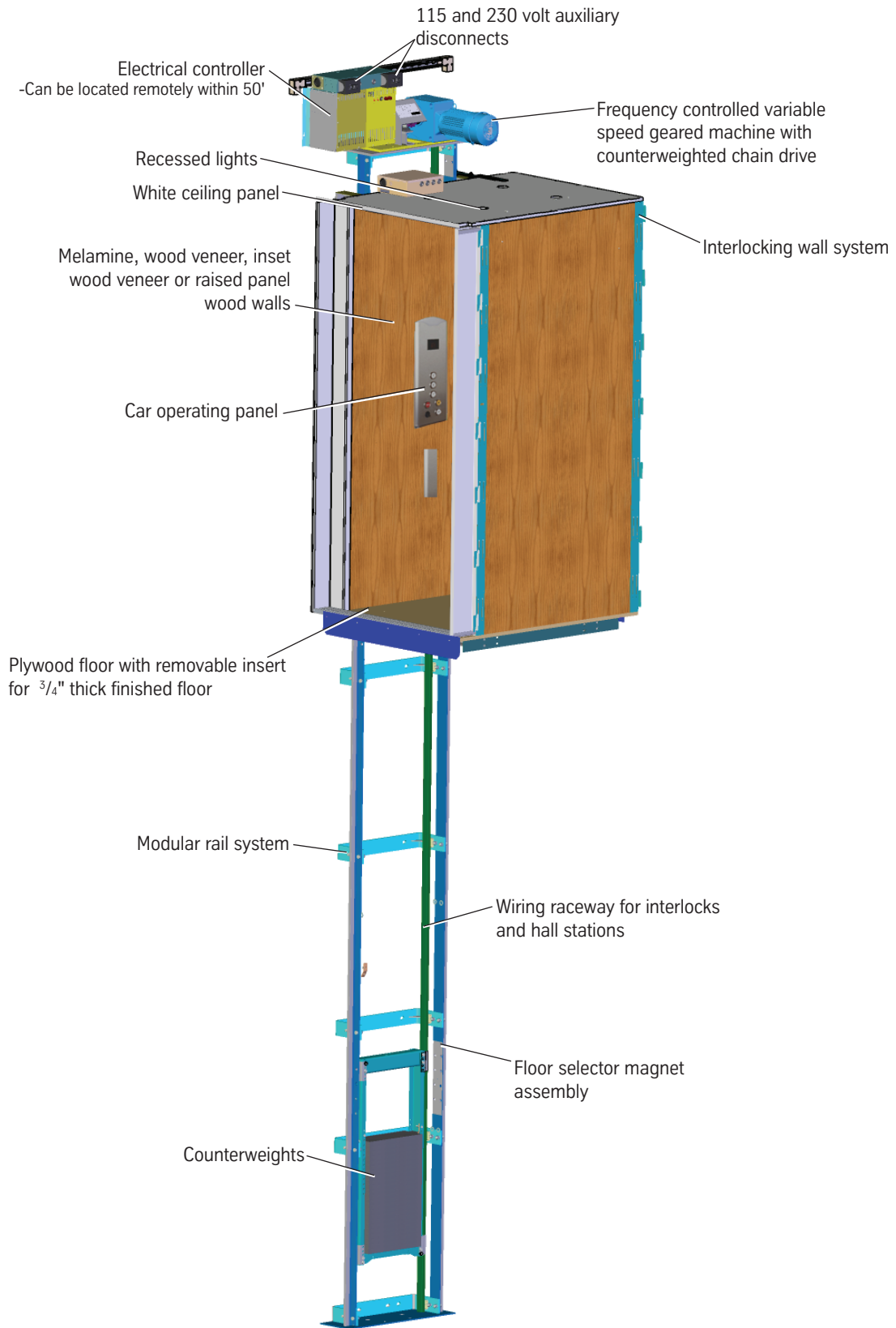



www.SunCoastElevator.Com